



MT SYSTEM

Modular Support System
Catalogue



Channels



Technical data

Material composition	S250GD EN 10346 MT-30
	S280GD EN 10346 MT-10/MT-15/MT-20/MT-40/MT-50/MT-60/MT-40D
Surface finish	Pre-galvanized Z275-for C1 indoor use EN 10346
	ZM, ZM310-for C3 outdoor use EN 10346 ASTM A1046

Item Description	Material Thickness (mm)	Dimensions (H x B)	Weight (g/m)	Sales Pack (m)	Item Number
MT-10	1.20	26.0 x 19.4	388	2	2268492
MT-15	1.50	35.0 x 27.0	678	2	2268493
MT-15 OC	1.50	35.0 x 27.0	678	2	2268494
MT-20	1.75	28.0 x 42.5	1267	2	2268495
MT-20 OC	1.75	28.0 x 42.5	1267	2	2268496
MT-30	2.00	23.0 x 42.5	1486	6	2268498
MT-30 OC	2.00	23.0 x 42.5	1486	6	2268500
MT-40 T	1.75	42.5 x 42.5	1690	6	2268502
MT-40 T OC	1.75	42.5 x 42.5	1690	6	2268504
MT-40	2.00	42.5 x 42.5	2039	6	2268506
MT-40 OC	2.00	42.5 x 42.5	2039	6	2268508
MT-50	2.75	42.5 x 42.5	2661	6	2268510
MT-50 OC	2.75	42.5 x 42.5	2661	6	2268512
MT-60	2.75	72.0 x 42.5	3853	6	2268514
MT-60 OC	2.75	72.0 x 42.5	3853	6	2268516
MT-40D	2.00	85.0 x 42.5	4299	6	2268518
MT-40D OC	2.00	85.0 x 42.5	4299	6	2268520

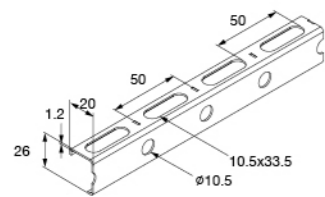

MT-10

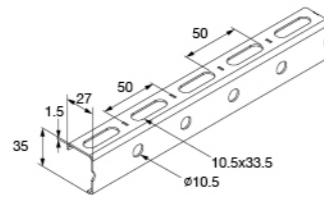

MT-15 / MT-15 OC

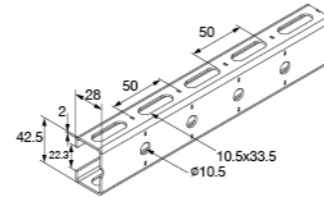

MT-20 / MT-20 OC

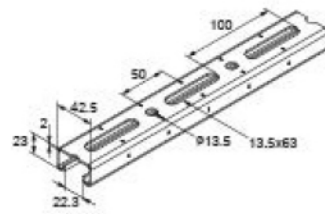

MT-30 / MT-30 OC

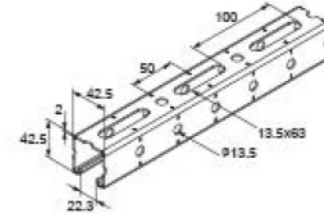

MT-40 / MT-40 OC

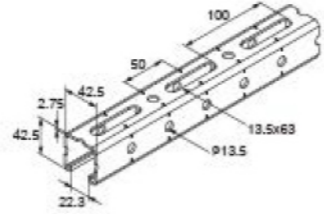

MT-50 / MT-50 OC

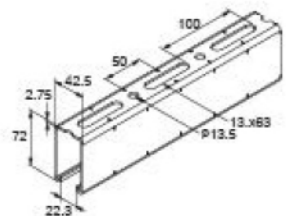

MT-60 / MT-60 OC

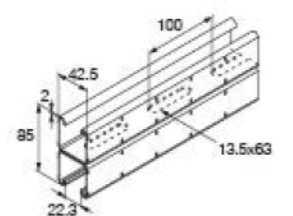

MT-40D / MT-40D OC

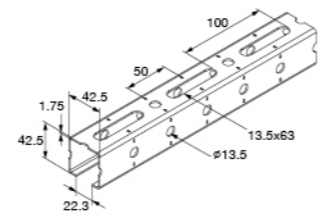

MT-40 T / MT-40 T OC

Girder



Technical data

Material composition	S350GD EN 10346
Surface finish	ZM310 ZM, ZM310-for C3 outdoor use EN 10346 ASTM A1046

Item Description	Material thickness	Height x Width	Weight	Sales pack	Item number
MT-70 OC	2.75	50 x 50	3909	6	2268365
MT-80 OC	3.0	100 x 50	6058	6	2268367
MT-90 OC	3.0	100 x 100	8973	6	2268369
MT-100 OC	4.0	150 x 100	15096	6	2268491

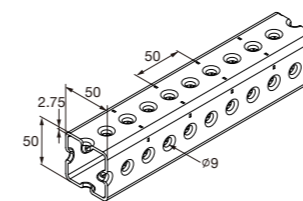

MT-70 OC

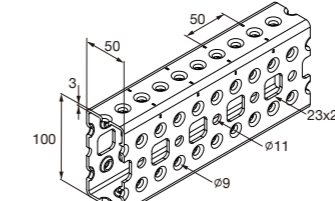

MT-80 OC

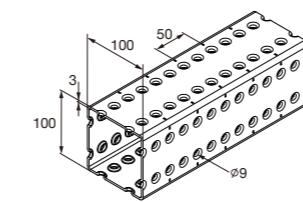

MT-90 OC

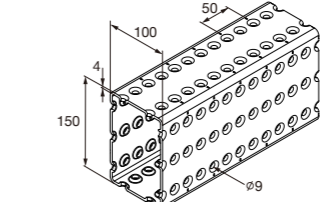

MT-100 OC

TECHNICAL DATA MT CHANNEL SYSTEM

Technical data for channel profile MT (pregalvanized & zinc magnesium)

Definition of axes

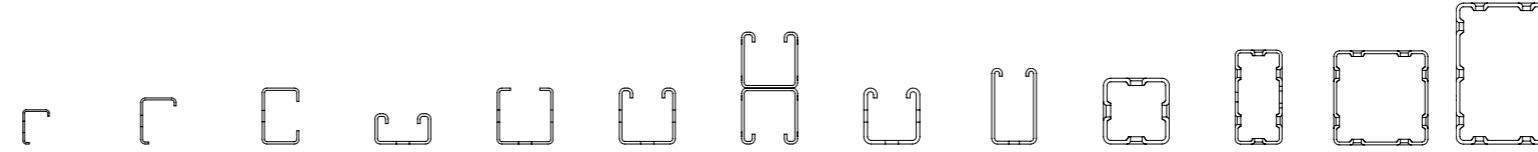
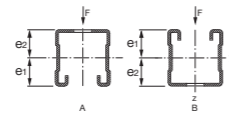

			MT-10	MT-15/ MT-15 OC	MT-20/ MT-20 OC	MT-30/ MT-30 OC	MT-40 T/ MT-40 T OC	MT-40 MT-40 OC	MT-40D/ MT-40D OC	MT-50/ MT-50 OC	MT-60/ MT-60 OC	MT-70 OC	MT-80 OC	MT-90 OC	MT-100 OC
Channel wall thickness	t	[mm]	1.2	1.5	1.75	2.0	1.75	2.0	2.0	2.75	2.75	2.75	3.0	3.0	4.0
Cross-sectional area	A	[mm ²]	48.43	85.2	148.65	180	175.59	214	429.52	276.05	500.1	428.78	592.66	976.08	1555.34
Channel weight		[kg/m]	0.3888	0.6784	1.267	1.486	1.69	2.039	4.299	2.744	4.017	3.909	6.058	8.973	15.096
Delivered length		[m]	2	2	2	3/6	6	3/6	3/6	3/6	3/6	3/6	3/6	3/6	3/6
Material															
Steel grade			S280GD	S280GD	S280GD	S250GD	S280GD	S280GD	S280GD	S280GD	S280GD	S350GD	S350GD	S350GD	S350GD
Permissible stress	δ_{perm}	[N/mm ²]	207.8	206.7	205.8	188.3	200.5	202.2	202.2	207.8	202.3	227.3	233.3	233.3	233.3
E-Modul		[N/mm ²]	210000	210000	210000	210000	210000	210000	210000	210000	210000	210000	210000	210000	210000
Surface															
pregalvanized (DIN EN ISO 10346)			•	•	•	•	•	•	•	•	•	•	•	•	•
zinc magnesium (EN 10346 & ASTM A1046)				•	•	•	•	•	•	•	•	•	•	•	•
Cross-section values Y-axis															
Axis of gravity A ¹⁾	e ₁	[mm]	9.25	11.90	21.25	12.04	23.05	21.76	42.50	22.04	36.62	25.00	50.00	50.00	75.00
Axis of gravity B	e ₂	[mm]	16.75	23.10	21.25	10.96	19.45	20.74	42.50	20.46	35.38	25.00	50.00	50.00	75.00
Moment of inertia	I _y	[cm ⁴]	0.40	1.27	3.65	1.21	4.84	5.77	29.96	7.04	28.67	15.87	87.97	150.85	487.36
Permtion modulus A	W _{y1}	[cm ³]	0.25	0.57	1.73	1.00	2.10	2.65	7.05	3.19	7.83	6.35	17.59	30.17	64.98
Permtion modulus B	W _{y2}	[cm ³]	0.41	1.00	1.73	1.10	2.48	2.78	7.05	3.44	8.10	6.35	17.59	30.17	64.98
Radius of gyration	i _y	[cm]	0.91	1.22	1.57	0.82	1.66	1.64	2.64	1.60	2.39	1.92	3.85	3.93	5.60
Permissible moment ²⁾	M _y	[Nm]	52	180	355	189	421	536	1425	663	1584	1443	4105	7040	15162
Z-axis															
Moment of inertia	I _z	[cm ⁴]	0.23	0.72	1.85	5.19	5.71	6.59	13.18	8.27	17.11	15.87	24.50	150.85	260.98
Permtion modulus	W _z	[cm ³]	0.15	0.36	1.07	2.44	2.69	3.10	6.20	3.89	8.05	6.35	9.80	30.17	52.20
Radius of gyration	i _z	[cm]	0.69	0.92	1.12	1.70	1.80	1.76	1.75	1.73	1.85	1.92	2.03	3.93	4.10

Design resistance

- MT-10 to MT-70: The permissible stress $\sigma_D / Y_{G/Q}$ where $\gamma = 1.4$. σ_D results from the higher yield strength (point) resulting from cold forming as per EN 1993-1-3: 2010: $\sigma_D = f_{yk} / Y_M$ where $Y_M = 1.1$.
 - MT-80 to MT-100: The permissible stress $\sigma_D / Y_{G/Q}$ where $\gamma = 1.5$.
- 1) For the arithmetical bending dimensioning is the smaller value (W_{y1} , W_{y2}) decisive to ($W_{y1} = I_y / e_1$ bzw. $W_{y2} = I_y / e_2$).
- 2) $M_y = \delta_{perm} \times \min. (W_{y1}, W_{y2})$

POINT LOAD IN THE MIDDLE OF SPAN

Technical data for channel profiles MT (max. span width/deflection - point Load in the middle of span)

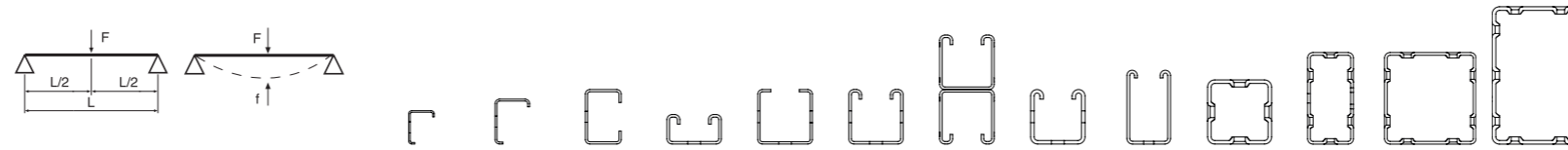

Max. span width L [cm] / deflection f [mm] - Result

load F [kN]	MT-10		MT-15/ MT-15 OC		MT-20/ MT-20 OC		MT-30/ MT-30 OC		MT-40 T/ MT-40 T OC		MT-40/ MT-40 OC		MT-40D/ MT-40D OC		MT-50/ MT-50 OC		MT-60/ MT-60 OC		MT-70 OC		MT-80 OC		MT-90 OC		MT-100 OC	
	L	f	L	f	L	f	L	f	L	f	L	f	L	f	L	f	L	f	L	f	L	f	L	f	L	f
0,25	83	0.4	157	7.8	260	12.9	152	7.6	294	14.7	317	15.8	600	29.4	339	16.9	600	29.9	469	23.4	600	11.6	600	8.3	600	3.6
0,50	42	0.1	93	3.2	188	9.3	109	5.5	215	10.7	234	11.7	489	24.4	254	12.6	482	24.1	368	18.4	600	17.7	600	11.9	600	4.7
0,75	28	0.0	62	1.4	155	7.7	90	4.5	178	8.9	194	9.6	418	20.9	212	10.6	411	20.5	311	15.5	600	23.8	600	15.4	600	5.8
1,00	21	0.0	47	0.8	134	6.6	75	3.5	154	7.6	169	8.4	371	18.5	185	9.3	363	18.1	274	13.6	600	29.9	600	19.0	600	6.9
1,25	17	0.0	37	0.5	113	5.0	60	2.3	134	6.2	151	7.6	336	16.8	167	8.3	329	16.4	247	12.3	551	27.5	600	22.5	600	8.0
1,50	14	0.0	31	0.4	94	3.4	50	1.6	112	4.3	138	6.9	309	15.4	152	7.6	302	15.0	227	11.3	512	25.6	600	26.1	600	9.1
1,75	12	0.0	27	0.3	81	2.5	43	1.2	96	3.2	122	5.5	287	14.4	141	7.0	281	14.0	211	10.5	479	23.9	600	29.6	600	10.2
2,00	10	0.0	23	0.2	71	1.9	38	0.9	84	2.4	107	4.2	270	13.5	132	6.5	264	13.2	198	9.9	452	22.6	572	28.6	600	11.3
2,25	9	0.0	21	0.2	63	1.5	34	0.7	75	1.9	95	3.3	248	11.6	117	5.1	249	12.4	187	9.3	429	21.4	545	27.2	600	12.4
2,50	8	0.0	19	0.1	57	1.2	30	0.6	67	1.6	86	2.7	224	9.5	106	4.2	237	11.8	177	8.8	409	20.4	522	26.0	600	13.5
2,75	8	0.0	17	0.1	52	1.0	27	0.5	61	1.3	78	2.2	204	7.9	96	3.5	227	11.3	169	8.4	391	19.5	501	25.0	600	14.6
3,00	7	0.0	16	0.1	47	0.9	25	0.4	56	1.1	71	1.9	188	6.7	88	2.9	208	9.6	162	8.1	376	18.8	482	24.1	600	15.7
3,50	6	0.0	13	0.1	41	0.6	22	0.3	48	0.8	61	1.4	161	4.9	76	2.1	179	7.1	150	7.5	349	17.4	450	22.5	600	17.9
4,00	5	0.0	12	0.1	36	0.5	19	0.2	42	0.6	54	1.1	141	3.8	66	1.6	157	5.4	141	7.0	328	16.3	424	21.2	600	20.1
4,50	5	0.0	10	0.0	32	0.4	17	0.2	37	0.5	48	0.8	126	3.0	59	1.3	140	4.3	128	5.9	310	15.5	401	20.0	600	22.3
5,00	4	0.0	9	0.0	28	0.3	15	0.1	34	0.4	43	0.7	113	2.4	53	1.1	126	3.5	115	4.8	295	14.7	382	19.0	600	24.5
6,00	3	0.0	8	0.0	24	0.2	13	0.1	28	0.3	36	0.5	95	1.7	44	0.7	105	2.4	96	3.3	270	13.5	350	17.5	600	28.9
7,00	3	0.0	7	0.0	20	0.2	11	0.1	24	0.2	31	0.3	81	1.2	38	0.5	90	1.8	82	2.4	232	10.0	325	16.2	571	28.5
8,00	3	0.0	6	0.0	18	0.1	9	0.1	21	0.2	27	0.3	71	1.0	33	0.4	79	1.4	72	1.9	204	7.7	305	15.2	537	26.8

Design resistance

Selection example:

- 1,0 kN (= 100 kg) should be carried by a channel with a channel span width L = 100cm (single span simply supported).

Solution:

- Select the line with the load, F = 1,0 kN.
- The channels MT-20, MT-40 T up to MT-100 can be used because the permissible span width (table value) is larger or equal to the required span width of L = 100cm.

Load tables are based on stress and deflection calculations, lateral torsional buckling is not considered.

POINT LOAD IN THE MIDDLE OF SPAN

Technical data for channel profiles MT (max. span width/deflection - point Load in the middle of span)

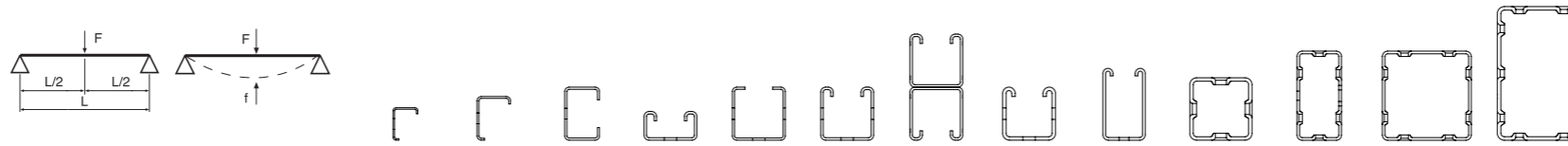

Max. span width L [cm] / deflection f [mm] - Result

span width L [cm]	MT-10		MT-15/ MT-15 OC		MT-20/ MT-20 OC		MT-30/ MT-30 OC		MT-40 T/ MT-40 T OC		MT-40/ MT-40 OC		MT-40D/ MT-40D OC		MT-50/ MT-50 OC		MT-60/ MT-60 OC		MT-70 OC		MT-80 OC		MT-90 OC		MT-100 OC	
	F	f	F	f	F	f	F	f	F	f	F	f	F	f	F	f	F	f	F	f	F	f	F	f	F	f
25	0.83	0.0	1.87	0.2	5.69	0.2	3.02	0.4	6.74	0.2	8.58	0.2	22.80	0.1	10.61	0.2	25.35	0.1	23.08	0.2	65.68	0.1	106.17	0.1	222.70	0.1
50	0.42	0.1	0.94	0.9	2.84	1.0	1.51	1.6	3.36	0.9	4.29	0.9	11.39	0.5	5.30	0.9	12.67	0.5	11.53	0.9	32.83	0.5	56.29	0.5	121.26	0.3
75	0.28	0.3	0.62	2.1	1.89	2.2	1.00	3.5	2.24	1.9	2.85	2.1	7.59	1.1	3.53	2.1	8.44	1.2	7.68	2.0	21.87	1.0	37.51	1.0	80.81	0.7
100	0.21	0.5	0.46	3.7	1.42	3.9	0.60	5.0	1.68	3.5	2.14	3.7	5.68	1.9	2.64	3.7	6.32	2.2	5.75	3.6	16.39	1.9	28.11	1.9	60.57	1.2
125	0.16	0.8	0.37	5.7	1.13	6.1	0.38	6.2	1.34	5.4	1.70	5.8	4.53	3.0	2.11	5.9	5.05	3.4	4.59	5.6	13.10	2.9	22.47	2.9	48.43	1.9
150	0.14	1.2	0.28	7.5	0.80	7.5	0.26	7.5	1.07	7.5	1.27	7.5	3.77	4.3	1.55	7.5	4.20	4.9	3.52	7.5	10.90	4.2	18.70	4.2	40.32	2.8
175	0.12	1.6	0.20	8.7	0.59	8.7	0.18	8.7	0.78	8.7	0.93	8.7	3.22	5.8	1.13	8.7	3.59	6.7	2.57	8.7	9.33	5.7	16.01	5.7	34.52	3.8
200	0.10	2.1	0.15	9.9	0.44	10.0	0.13	9.9	0.59	10.0	0.70	10.0	2.81	7.6	0.85	10.0	3.13	8.8	1.95	10.0	8.15	7.4	13.99	7.4	30.17	4.9
225	0.09	2.6	0.12	11.2	0.34	11.2	0.10	11.0	0.46	11.2	0.54	11.2	2.49	9.6	0.66	11.2	2.77	11.1	1.52	11.2	7.23	9.4	12.41	9.4	26.79	6.3
250	0.08	3.2	0.09	12.4	0.27	12.4	0.07	12.2	0.36	12.4	0.43	12.4	2.23	11.9	0.52	12.4	2.24	12.5	1.21	12.4	6.49	11.6	11.15	11.6	24.07	7.7
275	0.07	3.9	0.07	13.6	0.22	13.6	0.05	13.3	0.29	13.6	0.35	13.6	1.91	13.7	0.42	13.6	1.83	13.7	0.98	13.7	5.75	13.7	9.88	13.7	21.85	9.4
300	0.06	4.7	0.06	14.7	0.18	14.8	0.04	14.4	0.24	14.8	0.28	14.8	1.59	14.9	0.34	14.8	1.52	14.9	0.81	14.9	4.80	15.0	8.26	15.0	19.99	11.1
325	0.06	5.5	0.05	15.9	0.15	16.0	0.02	15.4	0.19	16.0	0.23	16.0	1.33	16.1	0.27	16.0	1.28	16.1	0.67	16.1	4.06	16.2	7.00	16.2	18.42	13.1
350	0.05	6.4	0.04	17.0	0.12	17.2	0.01	16.3	0.16	17.2	0.19	17.2	1.13	17.4	0.22	17.1	1.08	17.4	0.56	17.3	3.47	17.4	5.99	17.4	17.06	15.2
375	0.05	7.4	0.03	18.1	0.10	18.3		0.13	18.3	0.15	18.3	0.96	18.6	0.18	18.3	0.92	18.6	0.47	18.4	3.00	18.7	5.17	18.7	15.89	17.4	
400	0.04	8.5	0.02	19.1	0.08	19.4		0.11	19.4	0.13	19.4	0.83	19.8	0.15	19.4	0.79	19.8	0.39	19.6	2.60	19.9	4.50	19.9	14.86	19.9	
425	0.04	9.6	0.02	20.1	0.06	20.5		0.09	20.5	0.10	20.5	0.71	20.9	0.12	20.4	0.68	21.0	0.33	20.7	2.28	21.1	3.95	21.1	13.16	21.2	
450	0.04	10.8	0.01	21.1	0.05	21.6		0.07	21.6	0.08	21.6	0.61	22.1	0.09	21.5	0.59	22.1	0.27	21.9	2.00	22.3	3.48	22.3	11.66	22.4	
475	0.03	12.1	0.01	22.0	0.04	22.6		0.05	22.6	0.06	22.6	0.53	23.3	0.07	22.5	0.51	23.3	0.23	22.9	1.77	23.5	3.08	23.6	10.39	23.6	
500	0.03	13.5		0.03	23.6		0.04	23.6	0.05	23.6	0.46	24.4	0.05	23.4	0.44	24.4	0.19	24.0	1.56	24.7	2.73	24.8	9.30	24.9		

Design resistance

Load tables are based on stress and deflection calculations, lateral torsional buckling is not considered.

BUCKLING

Permissible buckling load for channel profile MT

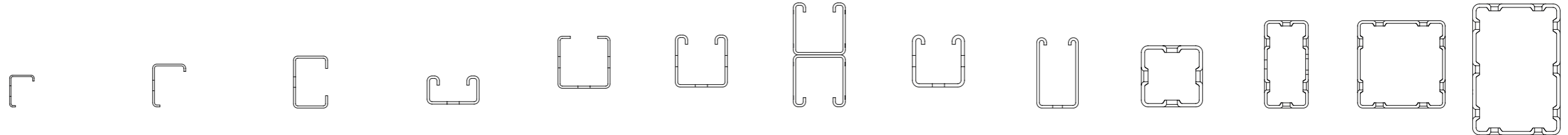

Buckling length Sk [cm]	MT-10	MT-15 / MT-15 OC	MT-20 / MT-20 OC	MT-30 / MT-30 OC	MT-40 T / MT-40 T OC	MT-40 / MT-40 OC	MT-40D / MT-40D OC	MT-50 / MT-50 OC	MT-60 / MT-60 OC	MT-70 OC	MT-80 OC	MT-90 OC	MT-100 OC
	permissible buckling load [kN]	permissible buckling load [kN]	permissible buckling load [kN]	permissible buckling load [kN]	permissible buckling load [kN]	permissible buckling load [kN]	permissible buckling load [kN]	permissible buckling load [kN]	permissible buckling load [kN]	permissible buckling load [kN]	permissible buckling load [kN]	permissible buckling load [kN]	permissible buckling load [kN]
25			29.40	30.51	34.41	42.22	87.97	55.68	68.93	99.01	128.31	219.78	350.41
50			24.86	22.72	29.93	36.62	80.21	47.92	52.16	90.61	118.07	210.74	336.93
75			19.67	15.10	24.91	30.33	72.00	39.23	36.33	81.79	107.42	202.00	323.55
100			14.70	10.03	19.75	23.90	62.95	30.58	25.80	72.10	95.79	193.28	310.24
125			10.86	7.02	15.34	18.45	53.45	23.51	19.47	61.82	83.33	184.34	296.65
150	N/A	N/A	8.19	5.16	12.00	14.38	44.43	18.32	15.55	51.88	70.94	175.02	282.54
175	N/A	N/A	6.33	3.96	9.58	11.44	36.66	14.62	12.97	43.12	59.66	165.24	267.77
200			5.03	3.13	7.82	9.31	30.34	11.94	11.18	35.87	50.05	155.00	252.31
225			4.08	2.54	6.51	7.73	25.32	9.97	9.86	30.04	42.18	144.40	236.27
250			3.37	2.11	5.52	6.54	21.35	8.46	8.86	25.40	35.81	133.67	219.89
275			2.83	1.78	4.75	5.62	18.20	7.29	8.06	21.68	30.67	123.05	203.52
300			2.41	1.52	4.14	4.89	15.67	6.36	7.41	18.70	26.51	112.80	187.54

Flexural buckling:
Rod length l (cm) / euler factor
 β/Sk (cm) effective length
 $= l \cdot \beta$

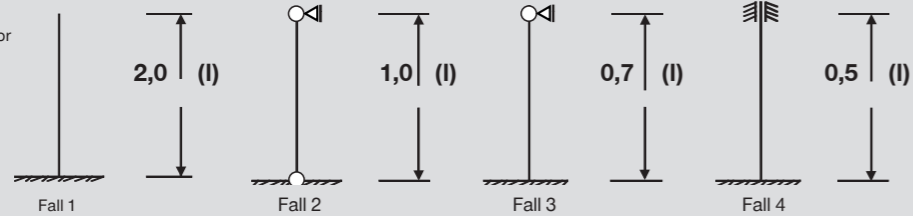

Design resistance

- MT-10 to MT-70: $\gamma_{M0} = 1,4 \rightarrow F_{0,0}^* =$ permissible buckling load x 1,4
- MT-80 to MT-100: $\gamma_{M0} = 1,5 \rightarrow F_{0,0}^* =$ permissible buckling load x 1,5
- Bend table is only valid for centric buckling loads. The values in this table aren't allowed for offset torque/oblique position/lateral-torsional buckling and must be engineered.

*(design value)

Twist Lock (MT-TL)



APPLICATIONS

- Fastening of any component, media to MT open C-channels with MT-TLB



ADVANTAGES

- Maximum connection reliability, no reliance on friction, no restriction of positioning steps For use with MT-TLB
- Fastening of any component, media to MT open C-channels with MT-TLB
- Guaranteed performance & productivity setting with SIW-AT module

Technical data

Surface finish	Pre-galvanized 12µm-for C1 indoor use HDG+ZiNi topcoat 20µm - for C3 outdoor use
----------------	---

Item Description	Thread - M	Weight	Sales pack	Item number
MT-TL M8	M8	32	50	2273630
MT-TL M8 OC	M8	32	50	2273631
MT-TL M10	M10	35	50	2272080
MT-TL M10 OC	M10	35	50	2272082
MT-TL M12	M12	38	50	2273632
MT-TL M12 OC	M12	38	50	2273633
MT-TL M16	M16	37	50	2273634
MT-TL M16 OC	M16	37	50	2273635

* MT-TL M10 is the primary size for connections within the system
* (with connectors & baseplates)

Item Description	Tightening torque - Nm	Shear Load - kN
MT-TL M10	30	8 7.2
MT-TL M10 OC	40	8 7.2

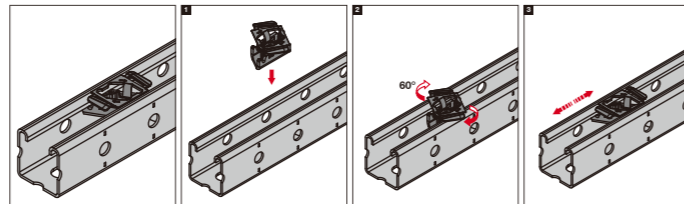

Twist-Lock Bolt (MT-TLB)



APPLICATIONS

- Fastening of any component, media to MT open C-channels with MT-TL
- For use with Twist-Lock MT-TL

Item Description	Thread - M	Thread length	Wrench size	Weight	Sales pack	Item number
MT-TLB	M10	24	17	25	50	2273254
MT-TLB OC	M10	24	17	25	50	2273256
MT-TLB 30	M10	30	17	31	50	2282190
MT-TLB 30 OC	M10	30	17	31	50	2282191

* MT-TLB is the primary size for connections within the system (with connectors & baseplates)

MT-TLB 30 is used only with brackets (MT-BR's) for fixation to open channels with TL's

Thread Forming Bolt (MT-TFB)



APPLICATIONS

- Fastening of any component, media to MT girders

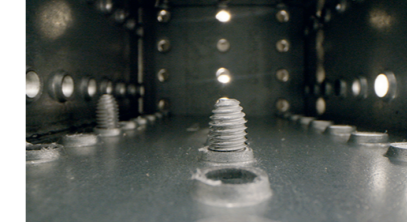

ADVANTAGES

- One bolt for all girder connections
- Fast installation easy to release
- One handed installation - No need for bolts or complex fixation elements
- Guaranteed performance & productivity setting with SIW-AT module
- Releasing, re-positioning, and subsequent re-torquing fully enabled

Item Description	Thread - M	Surface Finish	Weight	Sales pack	Item number
MT-TFB OC	M10	HDG+	28	50	2272084

Item Description	For Girder Types	Tightening torque - Nm	Pull out Load - kN	Shear Load - kN
MT-TFB OC	MT-70,MT-80	60	11	17
MT-TFB OC	MT-90	60	11	20
MT-TFB OC	MT-100	60	17	20

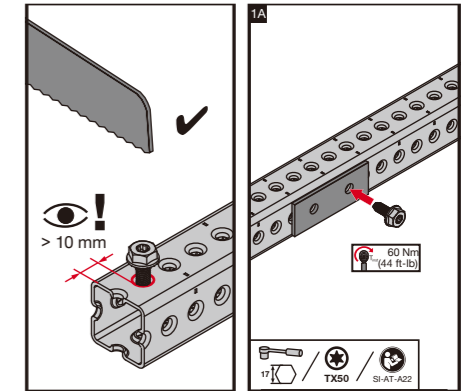

Channel/Girder End Caps (MT-EC)



APPLICATIONS

- Protection of channel/girder cut ends

Technical data

Material composition Polypropylene (PP)

Colour Red - RAL 3000

Item Description	For channel/girder types	Weight	Sales pack	Item number
MT-EC-30	MT-30	3.7	20	2273642
MT-EC-40/50	MT-40,50,40D	5.8	20	2273643
MT-EC-60	MT-60	9.1	20	2273644
MT-EC-70	MT-70	8.4	20	2273697
MT-EC-80	MT-80	15.4	20	2273698
MT-EC-90	MT-90	31.0	20	2273699
MT-EC-100	MT-100	45.5	20	2273700

Open C-Channel Baseplates



APPLICATIONS

- For fastening of MT channels to base material

ADVANTAGES

- Reliable and easy to use
- Connection of channels to any base material
- Simplest and most cost effective solution

Technical data

Material composition	Q235B GB/T 1591-2018	
Surface finish	Pre-galvanized galvanized 12µm-for C1 indoor use	ISO 2081
	HDG, 56µm-for C3 outdoor use	ASTM A153M

Item Description	Plate thickness	For Channel types	Weight	Sales pack	Item number
MT-B-L	4.0	MT-30,MT-40,MT-50,MT-60	119	20	2272086
MT-B-L OC	4.0	MT-30,MT-40,MT-50,MT-60	119	20	2272088
MT-B-T	4.0	MT-30,MT-40,MT-50,MT-60	565	20	2272090
MT-B-T OC	4.0	MT-30,MT-40,MT-50,MT-60	565	20	2272092
MT-B-O2	4.0	MT-30,MT-40,MT-50,MT-60	1027	12	2272094
MT-B-O2 OC	4.0	MT-30,MT-40,MT-50,MT-60	1027	12	2272096
MT-B-O2B	8.0	MT-40D	2072	6	2282212
MT-B-O2B OC	8.0	MT-40D	2072	6	2282213
MT-B-O4	8.0	MT-40D	3315	4	2272098
MT-B-O4 OC	8.0	MT-40D	3315	4	2272099

Item Description	Twist-Lock Qty.(pc)	-F _z Design Load kN	+F _z Design Load kN
MT-B-L	1	7.0	2.9
MT-B-T	2	12.6	8.4
MT-B-O2	2	14.0	12.6
MT-B-O2B	2	17.6	18.4
MT-B-O4	2	17.6	18.4

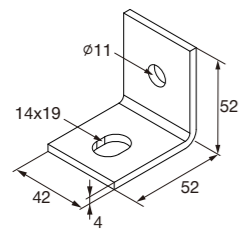

MT-B-L / MT-B-L OC

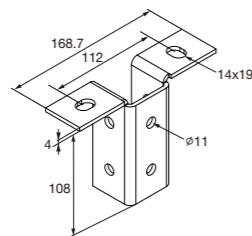

MT-B-T / MT-B-T OC

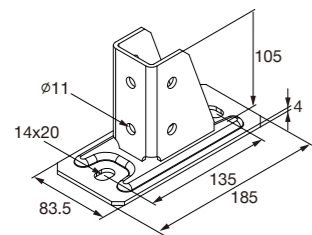

MT-B-O2 / MT-B-O2 OC

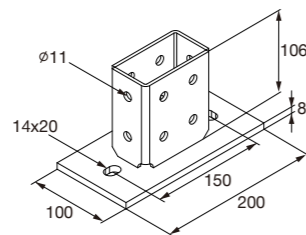

MT-B-O2B / MT-B-O2B OC

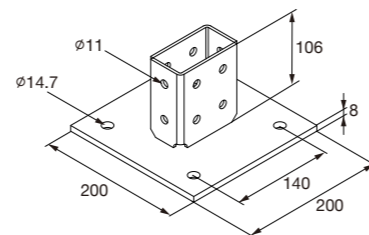

MT-B-O4 / MT-B-O4 OC

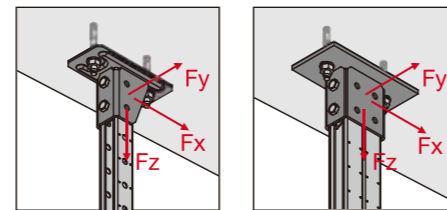
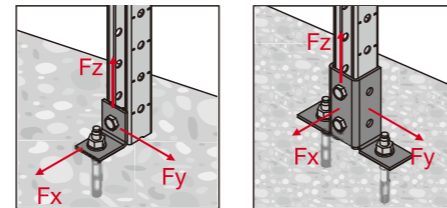

Open C-Channel Connectors



APPLICATIONS

- Assembly of frames and other structures using MT channels
- Simplest form of connectors, for building standard L junctions

ADVANTAGES

- Universal few parts for all applications
- Simplified connectors for multi purpose usage
- Easy to use
- Three-dimensional, thus high strength
- Direct fastening to girders possible (w/ TFB) for MT-C-L1/2

Technical data

Material composition	Q355B GB/T 1591-2018	
Surface finish	Pre-galvanized galvanized 12µm-for C1 indoor use	ISO 2081
	HDG, 56µm-for C3 outdoor use	ASTM A153M

90° Angle connector

Item Description	Angle	Material thickness	For Channel types	Weight	Sales pack	Item number
MT-C-L1	90°	6.0	MT-30,MT-40	199	20	2271514
MT-C-L1 OC	90°	6.0	MT-50,MT-60	199	20	2271516
MT-C-L2	90°	6.0	MT-30~MT-100	257	20	2271518
MT-C-L2 OC	90°	6.0	MT-30~MT-100	257	20	2271519
MT-C-LL1	90°	4.0	MT-30,MT-40	334	10	2272047
MT-C-LL1 OC	90°	4.0	MT-50,MT-60	334	10	2272049
MT-C-LL2	90°	4.0	MT-30,MT-40	592	10	2272051
MT-C-LL2 OC	90°	4.0	MT-50,MT-60	592	10	2272053

* MT-C-L2/MT-C-L2 OC

kN Item Description	Twist-Lock Qty.	-F _z Design Load kN	+F _z Design Load kN
MT-C-L1	2	5.6	4.6
MT-C-L2	3	7.0	7.0
MT-C-LL1	2	5.2	7.0
MT-C-LL2	4	6.5	5.8

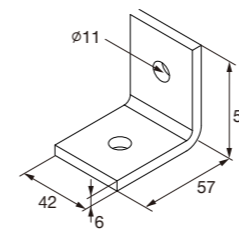

MT-C-L1 / MT-C-L1 OC

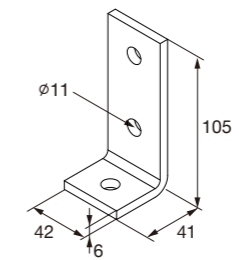

MT-C-L2 / MT-C-L2 OC

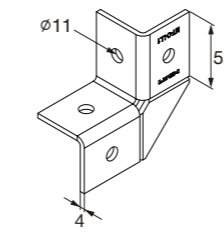

MT-C-LL1 / MT-C-LL1 OC

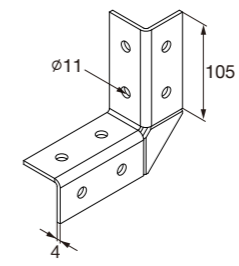

MT-C-LL2 / MT-C-LL2 OC

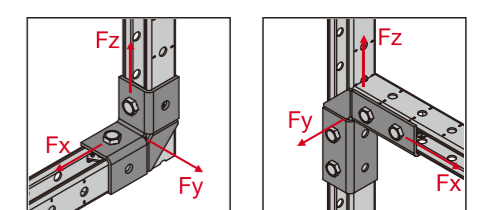
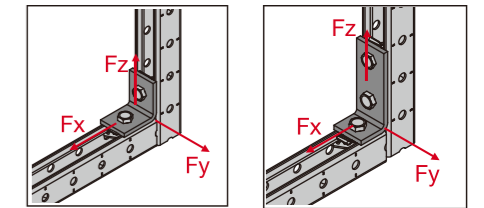

Angle Brace Connectors



APPLICATIONS

- 5b[Y V f U M] b[k] h ' A H ' W U b b Y ' g '

ADVANTAGES

- Wide range of channel compatibility
- Possibility to be used as baseplate (MT-AB A and MT-AB L

Technical data

Material composition Q235B GB/T 700-2006

Surface finish Pre-galvanized galvanized 12µm-for C1 indoor use ISO 2081

Surface finish HDG, 56µm-for C3 outdoor use ASTM A153M

45° Angle connector

Item Description	Angle	Material thickness	For Channel types	重量(g) Weight	包装数量(pcs) Sales pack	品号 Item number
MT-AB A	Adjustable	4.0	MT-40,MT-50	441	12	2272111
MT-AB A OC	Adjustable	4.0	MT-40,MT-50	441	12	2272112
MT-AB L 45	45°	4.0	MT-40,MT-50	427	10	2272113
MT-AB L 45 OC	45°	4.0	MT-40,MT-50	427	10	2272114
MT-AB LL2	45°	4.0	MT-40,MT-50	553	10	2272115
MT-AB LL2 OC	45°	4.0	MT-60,MT-40D	553	10	2273585

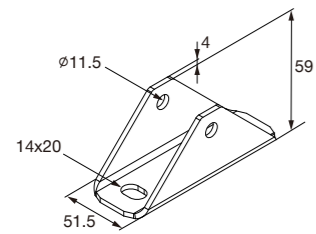

MT-AB A / MT-AB A OC

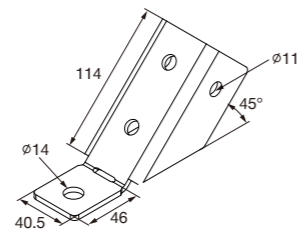

MT-AB-L 45 / MT-AB-L 45 OC

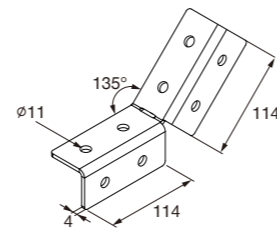

MT-AB-LL2 / MT-AB-LL2 OC

Splice Connectors

Item Description	Material thickness	For Channel types	Weight	Sales pack	Item number
MT-ES-40	4.0	MT-30,MT-40,MT-50,	805	12	2272062
MT-ES-40 OC	4.0	MT-60,MT-40D	805	12	2272063

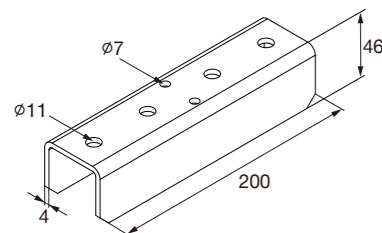

MT-ES-40 / MT-ES-40 OC

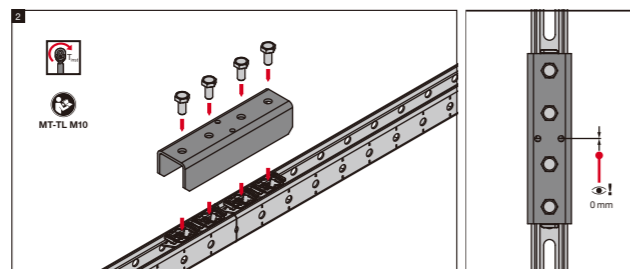

Transverse Connectors - 2D

Item Description	Material	Material thickness	Weight	Sales pack	Item number
MT-C-T/1	Q235B	6.0	435	20	2272040
MT-C-T/1 OC	Q235B	6.0	435	20	2272042
MT-C-T/2	Q355B	4.0	782	15	2272054
MT-C-T/2 OC	Q355B	4.0	782	15	2272055
MT-C-T A	Q355B	4.0	323	20	2272056
MT-C-T A OC	Q355B	4.0	323	20	2272057

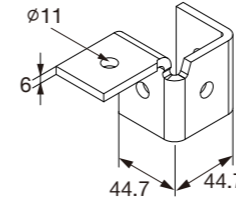

MT-C-T/1 / MT-C-T/1 OC

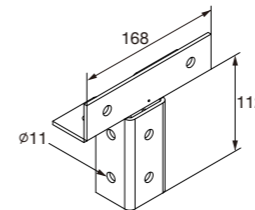

MT-C-T/2 / MT-C-T/2 OC

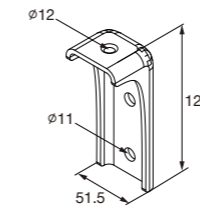

MT-C-T A / MT-C-T A OC

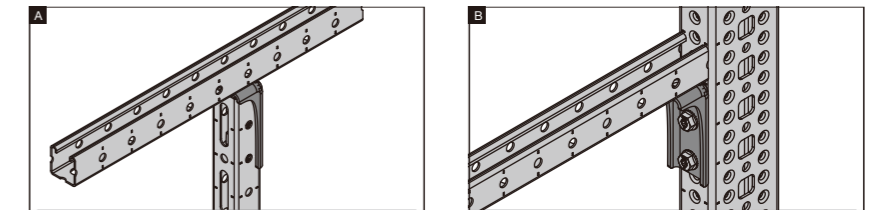
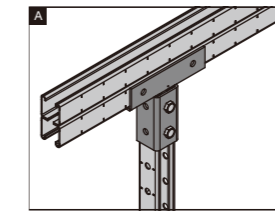
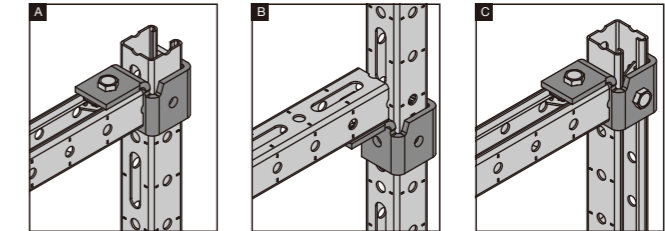

Item Description	Twist-Lock Qty.(pc)	+F _z Design Load kN	
MT-C-T/1	2	4.3	5.5
MT-C-T/2	4	11.9	11.3
MT-C-T A	2	14	8.8

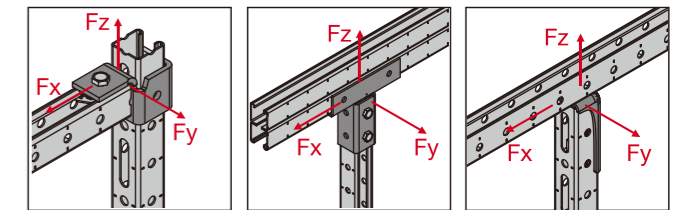

Transverse Connectors - 3D

Item Description	Material	Material thickness	Weight	Sales pack	Item number
MT-C-T 3D/2	Q235B	6.0	418	10	2272058
MT-C-T 3D/2 OC	Q235B	6.0	418	10	2272059
MT-C-T 3D/3	Q235B	6.0	629	10	2272060
MT-C-T 3D/3 OC	Q235B	6.0	629	10	2272061

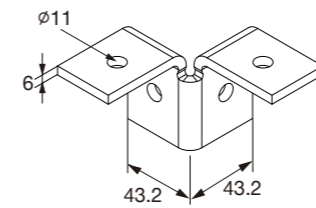

MT-C-T 3D/2 / MT-C-T 3D/2 OC

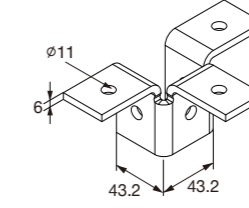

MT-C-T 3D/3 / MT-C-T 3D/3 OC

Girder Baseplates

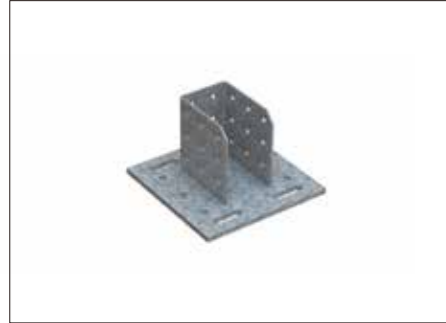

APPLICATIONS

- For fastening of MT channels to base material (concrete)

ADVANTAGES

- Connection of girders to both concrete and steel for MT-B-GS connectors

Technical data

Material composition Q355B GB/T 1591-2018

Surface finish HDG, 56µm-for C3 outdoor use ASTM A153M

Item Description	Plate thickness	For Girder Types	Weight	Sales pack	Item number
MT-B-GS T OC	8.0	MT-70,MT-80	2166	2	2272100
MT-B-GS O4U OC	12.0	MT-70,MT-80	4730	4	2272101
MT-B-GL O4 OC	12.0	MT-90	14910	1	2272103
MT-B-GXL O4 OC	12.0	MT-100	17031	1	2272104

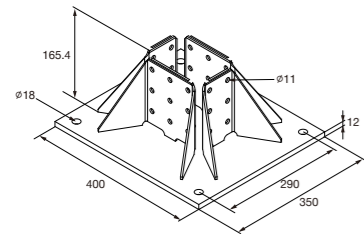

MT-B-GXL O4 OC

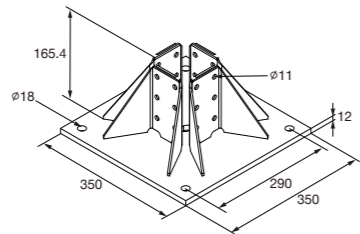

MT-B-GL O4 OC

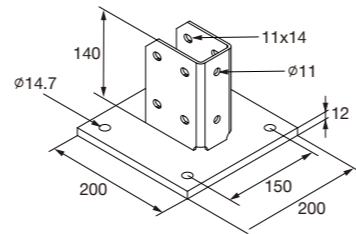

MT-B-GS O4U OC

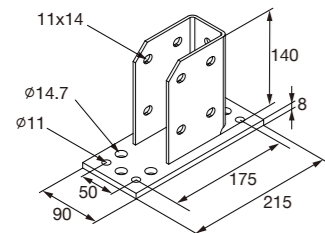

MT-B-GS T OC

Item Description	±F _z Design Load kN	+F _z Design Load kN
MT-B-GS T OC	33.4	25.9
MT-B-GS O4U OC	27.0	90.1
MT-B-GL O4 OC	82.8	183.6
MT-B-GXL O4 OC	140.1	218.6

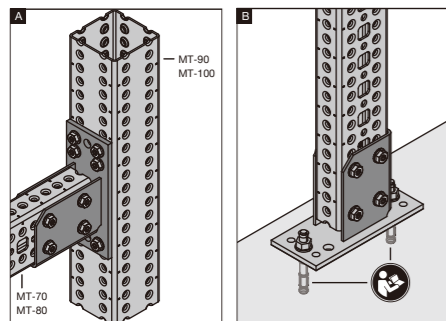

*MT-B-GS T OC

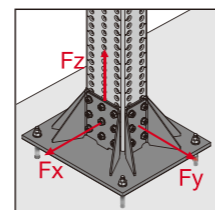
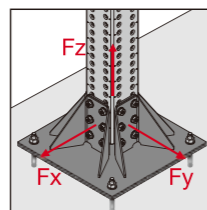
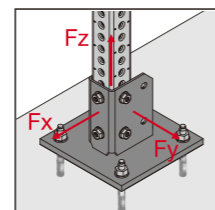
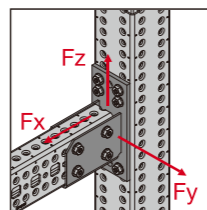

Girder Baseplates



APPLICATIONS

- For fastening of MT channels to base material (steel)

ADVANTAGES

- Connection of girders to I-beam with sandwich plates

Technical data

Material composition Q355B GB/T 1591-2018

Surface finish HDG, 56µm-for C3 outdoor use ASTM A153M

Item Description	Plate thickness	I-beam width (mm)	Weight	Sales pack	Item number
MT-B-GXL S1 OC	15.0	75-165	9401	2	2272106
MT-B-GXL S2 OC	15.0	165-235	9365	2	2272107
MT-B-GXL S3 OC	15.0	235-305	10816	2	2272108
MT-P-GXL S1 OC	15.0	75-165	6902	2	2272110

* MT-B-GXL S1/2/3 OC

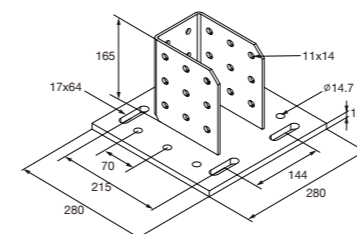

MT-B-GXL S1 OC

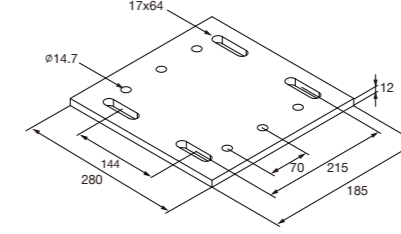

MT-P-GXL S1 OC

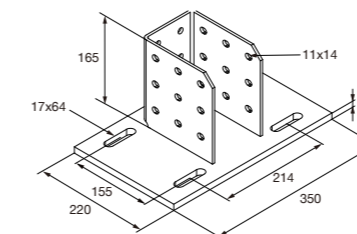

MT-B-GXL S2 OC

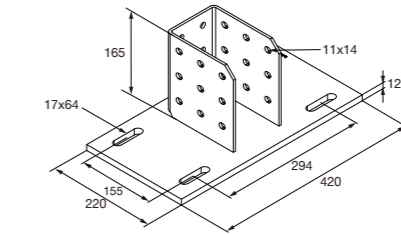

MT-B-GXL S3 OC

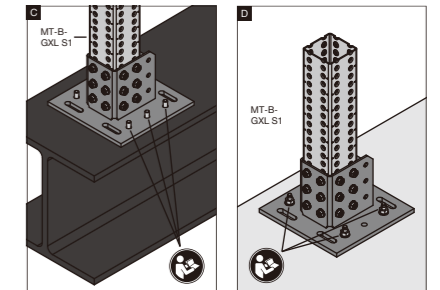
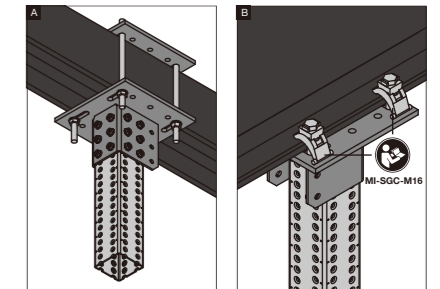

* MT-B-GXL S1 OC
 * MT-P-GXL-S1 OC
 * MT-B-GXL S2 OC, MT-B-GXL S3 OC



Item Description	Plate thickness	For Girder Types	Weight	Sales pack	Item number
MT-B-G WS OC	6.0	MT-70,MT-80 MT-90,MT-100	4345	4	2272109

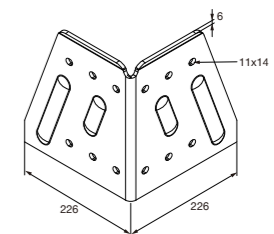
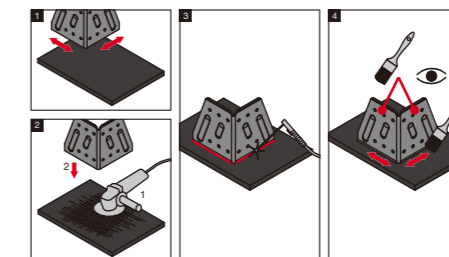

MT-B-G WS OC

Girder Connectors



APPLICATIONS

- Simplest form of connectors, for building standard L junctions with MT girders

ADVANTAGES

- Possibility to be used as baseplate.
- Designed to provide extra adjustability

Technical data

Material composition	Q355B GB/T 1591-2018		
Surface finish	HDG, 56µm-for C3 outdoor use	ASTM A153M	

90° Angle connector

Item Description	Angle	Material thickness	For Girder Types	adjustment	Weight	Sales pack	Item number
MT-C-GS OC	90°	3.0	MT-70,MT-80	25	400	10	2272064
MT-C-GL OC	90°	4.0	MT-90,MT-100	25	1161	10	2272066
MT-C-GS A OC	90°	3.0	MT-70,MT-80	5	390	10	2272068
MT-C-GL A OC	90°	4.0	MT-90,MT-100	5	1145	10	2272069

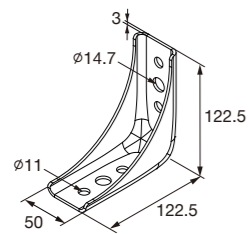

MT-C-GS OC

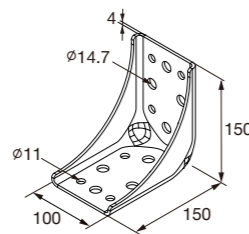

MT-C-GL OC

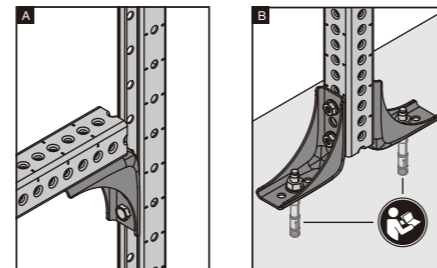

* MT-C-GS OC/ MT-C-GL OC

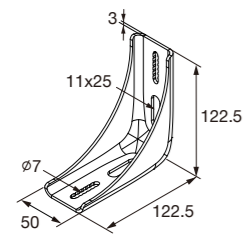

MT-C-GS A OC

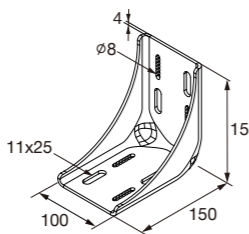

MT-C-GL A OC

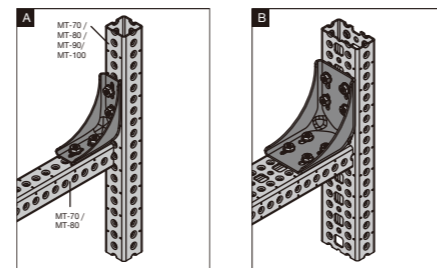

* MT-C-GS A OC / MT-C-GL A OC

Girder Connectors

Item Description	Material thickness	Surface finish	Weight	Sales pack	Item number
MT-C-GSP L OC	4.0	HDG	424	10	2272073
MT-C-GSP T OC	4.0	HDG	455	10	2272074
MT-C-GLP T OC	4.0	HDG	884	8	2272075

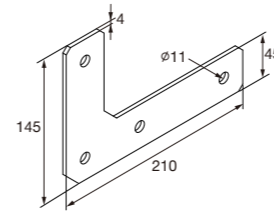

MT-C-GSP L OC

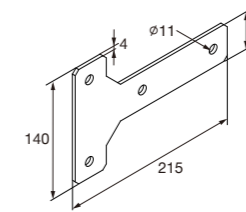

MT-C-GSP T OC

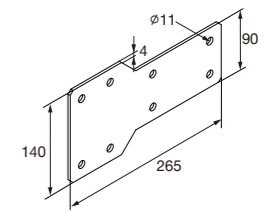

MT-C-GLP T OC

T-Post Connector (U-shaped)

Item Description	Material thickness	Surface finish	Weight	Sales pack	Item number
MT-U-GL1 OC	4.0	HDG	8827	2	2272070

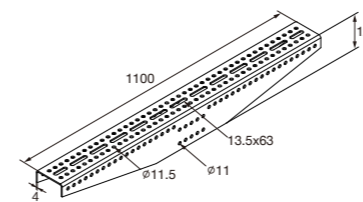

MT-U-GL1 OC

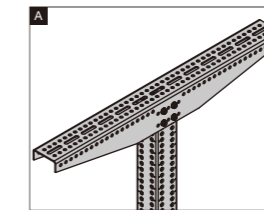

MT-U-GL OC

Splice Connectors

Item Description	Material thickness	Surface finish	Weight	Sales pack	For Girder Types	Item number
MT-ES-70 OC	5.0	HDG	1831	8	MT-70,MT-80	2272078
MT-ES-90 OC	6.0	HDG	4429	4	MT-90,MT-100	2272076

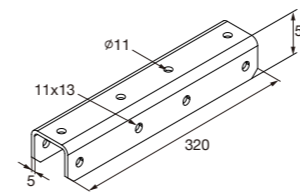

MT-ES-70 OC

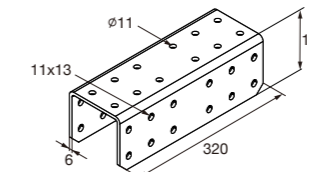

MT-ES-90 OC

Angle bracing connector

Item Description	Angle	Material thickness	Surface finish	Weight	Sales pack	Item number
MT-AB-G T OC	30°~60°	4.0	HDG	348	4	2272116

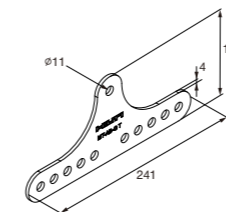

MT-AB-G T OC

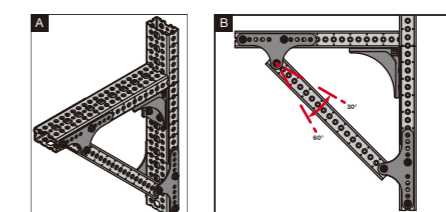

* MT-AB-G T Angle 30°~60°

